

PNP High Power Bipolar Transistor

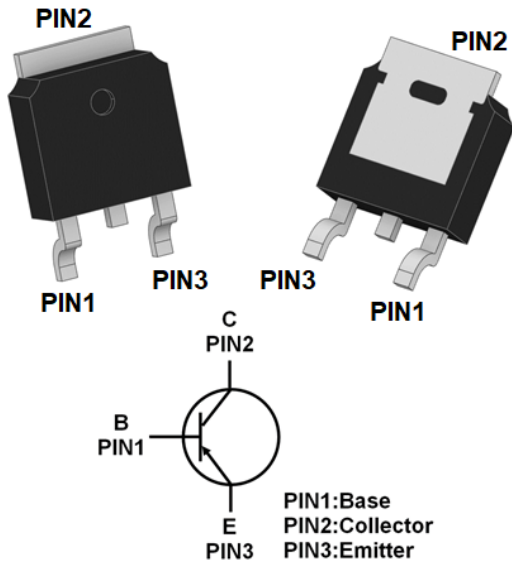

Features

- Epoxy Meets UL 94 V-0 Flammability Rating
- Halogen Free

Applications

- Complement to MJD122
- High DC Current Gain

Mechanical Data

- Package: TO-252
- Terminals: Tin plated leads, solderable per J-STD-002 and JESD22-B102
- Unit Weight: 0.32g

■ Maximum Ratings (Ta=25°C unless otherwise noted)

Item	Symbol	Unit	Value
Device marking code			MJD127
Collector-base voltage	V_{CBO}	V	-100
Collector-emitter voltage	V_{CEO}	V	-100
Emitter-base voltage	V_{EBO}	V	-5
Collector current	I_C	A	-5
Power dissipation(Note1)	P_D	W	1.5
Thermal resistance, junction-to-ambient (°)	R_{thJA}	°C/W	83.3
Junction temperature	T_j	°C	-55 to +150
Storage temperature	T_{STG}	°C	-55 to +150

Note1: The data tested by surface mounted on a 40*40*1.1mm heatsink.



■ Electrical Characteristics (Ta=25°C unless otherwise noted)

Item	Symbol	Unit	Conditions	Min	Typ	Max
Collector-base breakdown voltage	$V_{(BR)CBO}$	V	$I_C=-1mA, I_E=0$	-100		
Collector-emitter breakdown voltage	$V_{(BR)CEO}$	V	$I_C=-30mA, I_B=0$	-100		
Emitter-base breakdown voltage	$V_{(BR)EBO}$	V	$I_E=-2mA, I_C=0$	-5		
Collector-base cut-off current	I_{CBO}	mA	$V_{CB}=-100V$			-0.2
Collector cutoff current	I_{CEO}	mA	$V_{CE}=-30V$			-0.5
Emitter-base cut-off current	I_{EBO}	mA	$V_{EB}=-5V$			-2
DC current gain	h_{FE}		$V_{CE}=-3V, I_C=-0.5A$	1000		
			$V_{CE}=-3V, I_C=-3A$	1000		
Collector-emitter saturation voltage	$V_{CE(sat)}$	V	$I_C=-3A, I_B=-12mA$			-2.0
			$I_C=-5A, I_B=-20mA$			-4.0
Base-Emitter Voltage	V_{BE}	V	$V_{CE}=-3V, I_C=-3A$			-2.5
Collector-base output capacitance	Cob	pF	$V_{CB}=-10V, I_E=0A, f=1MHz$		88	

■ Ordering Information (Example)

PREFERRED P/N	PACKING CODE	MINIMUM PACKAGE(pcs)	INNER BOX QUANTITY(pcs)	OUTER CARTON QUANTITY(pcs)	DELIVERY MODE
MJD127	F2	2500	5000	25000	13"Reel



■ Characteristics(Typical)

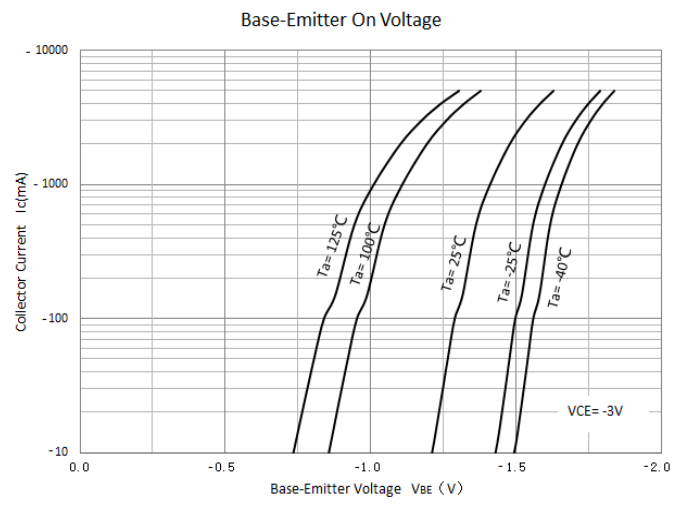
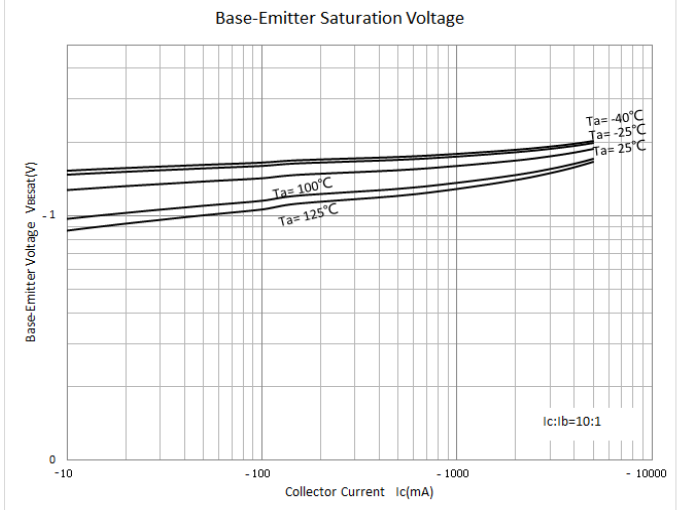
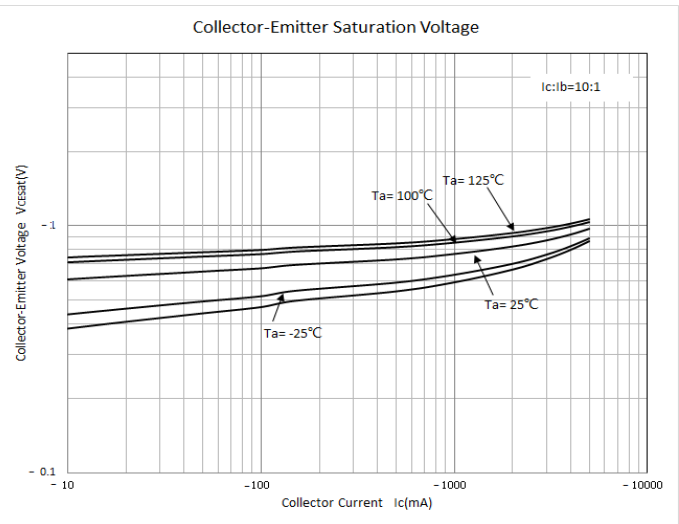
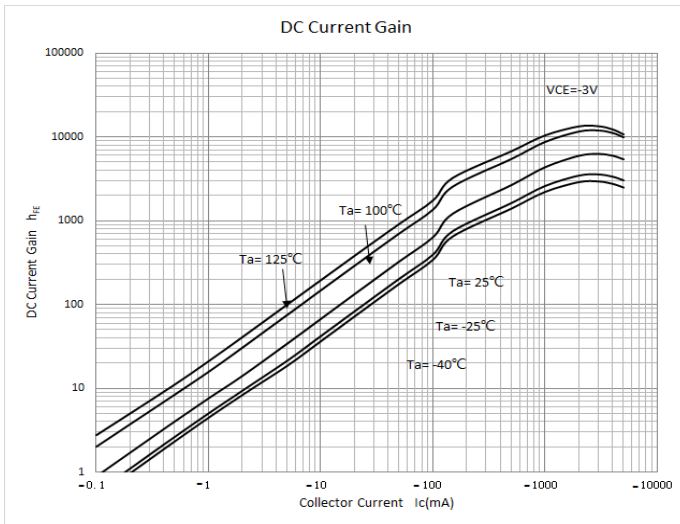
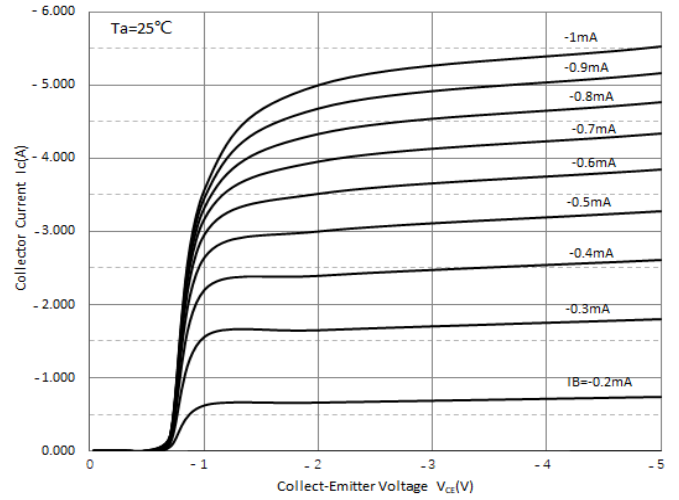
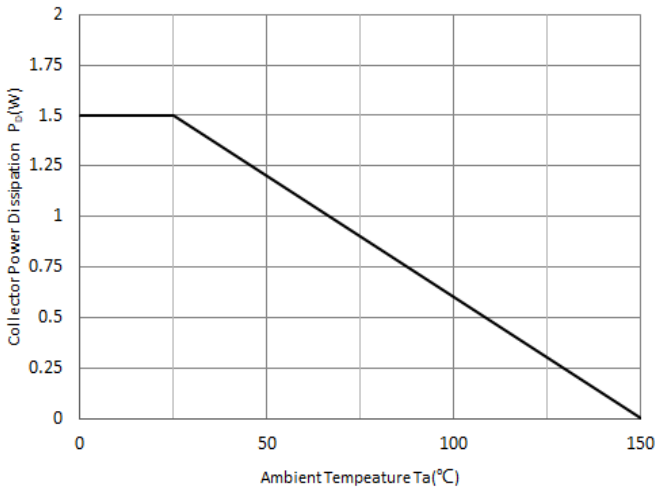

■ TO-252 Package information

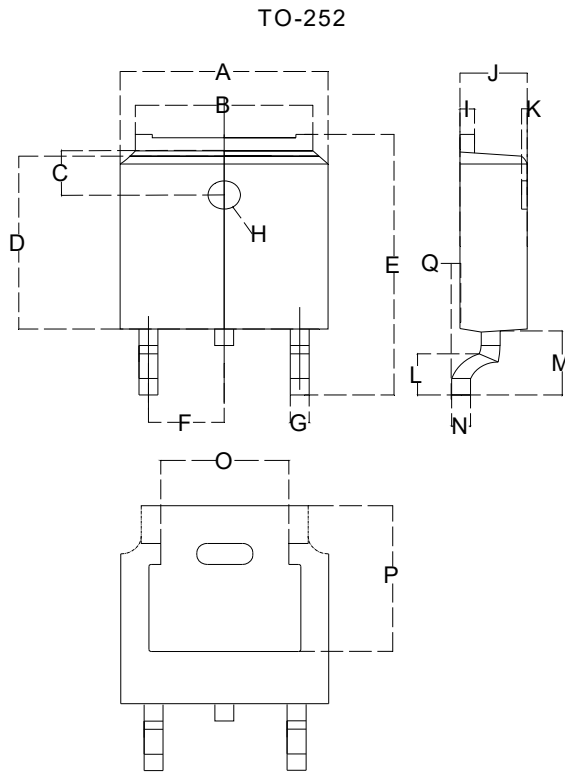

Dimensions in millimeters

TO-252		
Dim	Min	Max
A	6.500	6.700
B	5.100	5.460
C	1.400	1.800
D	6.000	6.200
E	10.000	10.400
F	2.166	2.366
G	0.660	0.860
H	Φ 1.050	Φ 1.350
I	0.460	0.580
J	2.200	2.400
K	0	0.300
L	0.890	2.290
M	2.730	3.080
N	0.430	0.580
O	4.20	4.95
P	5.15	5.45
Q	0	0.2

■ Suggested Pad Layout

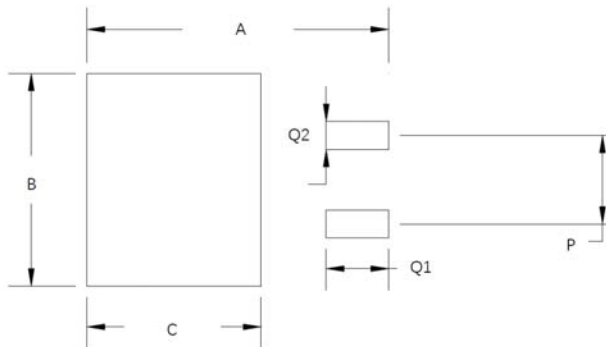

Dim	Millimeters
A	11.4
B	6.74
C	6.23
P	4.56
Q1	2.28
Q2	1.52



Disclaimer

The information presented in this document is for reference only. Yangzhou Yangjie Electronic Technology Co., Ltd. reserves the right to make changes without notice for the specification of the products displayed herein to improve reliability, function or design or otherwise.

The product listed herein is designed to be used with automotive electronics, are not designed for use in medical, life-saving, lifesustaining, or military, Yangjie or anyone on its behalf, assumes no responsibility or liability for any damages resulting from such improper use of sale.

This publication supersedes & replaces all information previously supplied. For additional information, please visit our website [http:// www.21yangjie.com](http://www.21yangjie.com) , or consult your nearest Yangjie's sales office for further assistance.