

Schottky Rectifier

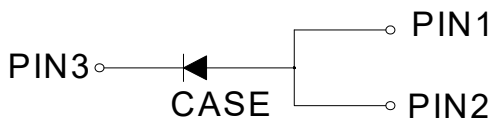
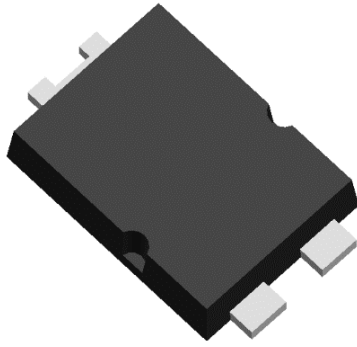

Features

- Ideal for automated placement
- Low power losses
- High forward surge capability
- Meets MSL level1, per J-STD-020, LF maximum peak of 260 °C
- Part no. with suffix "Q" means AEC-Q101 qualified

Typical Applications

For use in lighting, fast switching rectification of power suppliers, DC/AC inverters, DC/DC converters, and freewheeling diodes for polarity protection application for consumer, automotive and telecommunication.

Mechanical Data

- **Package:** TO-277
Molding compound meets UL 94 V-0 flammability rating, RoHS-compliant, Halogen free
- **Terminals:** Tin plated leads, solderable per J-STD-002 and JESD22-B102

■Maximum Ratings (T_a=25°C Unless otherwise specified)

PARAMETER	SYMBOL	UNIT	SS15U100PQ
Device marking code			SS15U100P
Repetitive Peak Reverse Voltage	V _{RRM}	V	100
Average Rectified Output Current @60Hz -sine wave	I _O	A	15
Forward Surge Current (Non-repetitive) @60Hz Half-sine wave, 1 cycle, T _a =25°C	I _{FSM}	A	300
Current Squared Time @1ms≤t≤8.3ms T _J =25°C	I ² t	A ² s	373.5
Non-repetitive avalanche energy at I _{AS} =2.0 A, T _J = 25°C	E _{AS}	mJ	20
Storage Temperature	T _{stg}	°C	-55 ~+175
Junction Temperature	T _J	°C	-55 ~+175

■Electrical Characteristics (T_a=25°C Unless otherwise specified)

PARAMETER	SYMBOL	UNIT	TEST CONDITIONS		Typ	Max
Instantaneous forward voltage	V _F	V	I _F =15A	T _A =25°C	0.78	0.88
			I _F =15A	T _A =125°C	0.7	0.8
Typical junction capacitance	C _J	pF	V _R =4V, f=1 MHz		420	-
Leakage Current	I _R	μA	V _R =100V	T _A =25°C	-	10
		mA		T _A =125°C	-	20



SS15U100PQ

■ Thermal Characteristics (T_a=25°C Unless otherwise specified)

PARAMETER	SYMBOL	UNIT	SS15U100PQ
Typical Thermal Resistance	R _{θJ-A}	°C/W	75
	R _{θJ-C}	°C/W	5

■ Ordering Information (Example)

PREFERED P/N	PACKAGE CODE	UNIT WEIGHT(g)	MINIMUM PACKAGE(pcs)	OUTER CARTON QUANTITY(pcs)	DELIVERY MODE
SS15U100PQ	F1	Approximate 0.106	5000	80000	13" reel

■ Marking Information

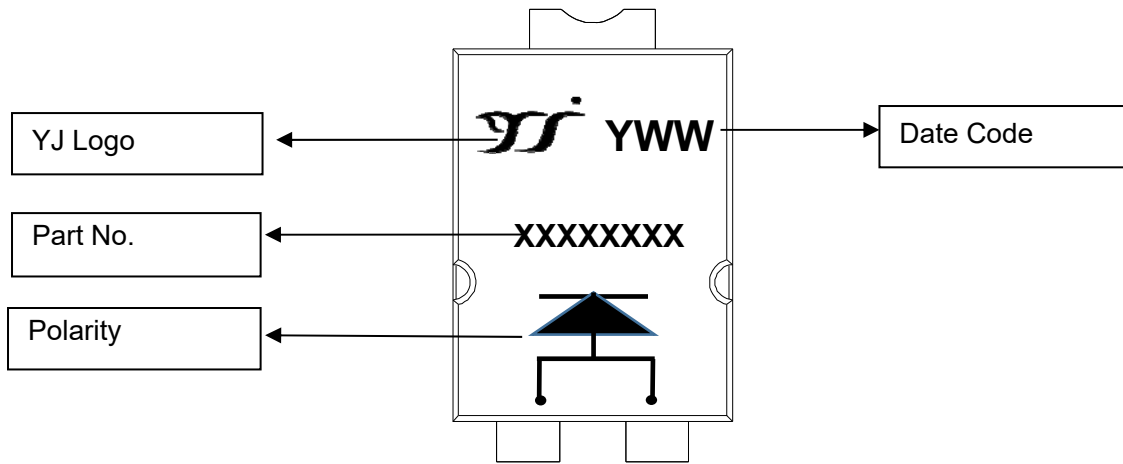

Note:

1. All marking is at middle of the product body
2. All marking is in laser printing
3. XXXXXX is part no., like SS15U100P.
4. Body color: Black
5. YWW is date code, "Y" is year. "WW" is week.

For instance: The 15th week of 2019, date code is 915



SS15U100PQ

■ Characteristics (Typical)

Fig.1:Forward Current Derating Curve

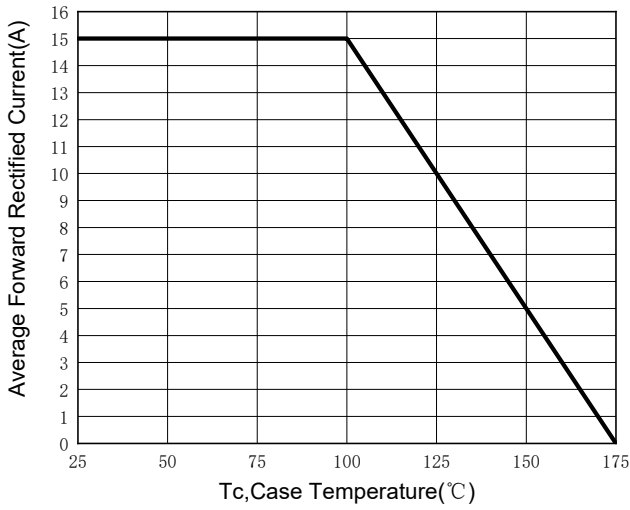

Fig.2:Forward Surge Current Capability

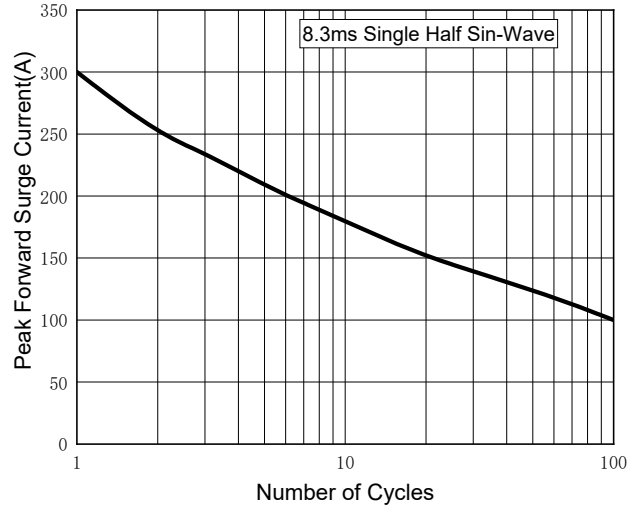

Fig.3:Typical Instantaneous Forward Characteristics

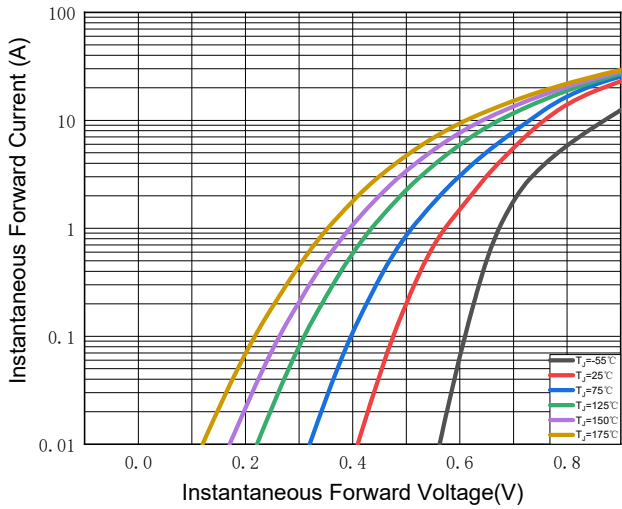

Fig.4:Typical Reverse Leakage Characteristics

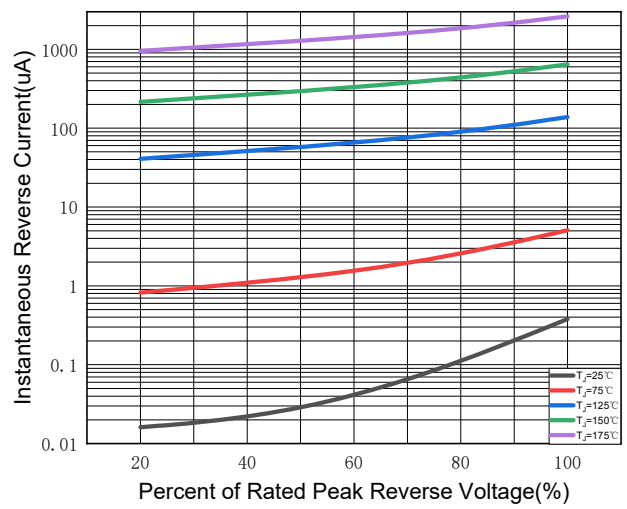
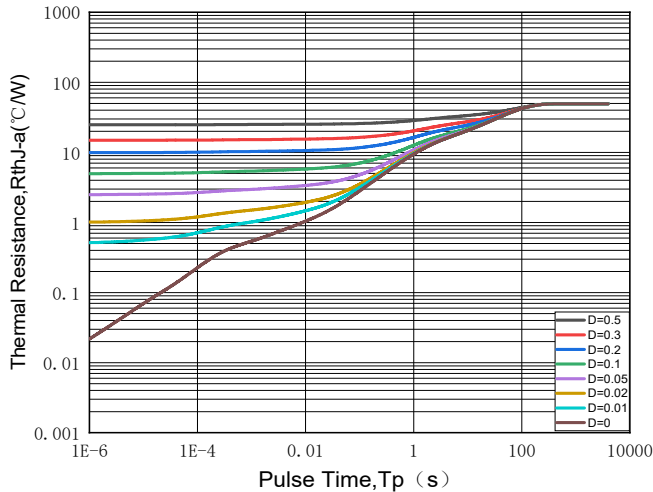

Fig.5 Typical Transient Thermal Impedance





SS15U100PQ

■ Outline Dimensions

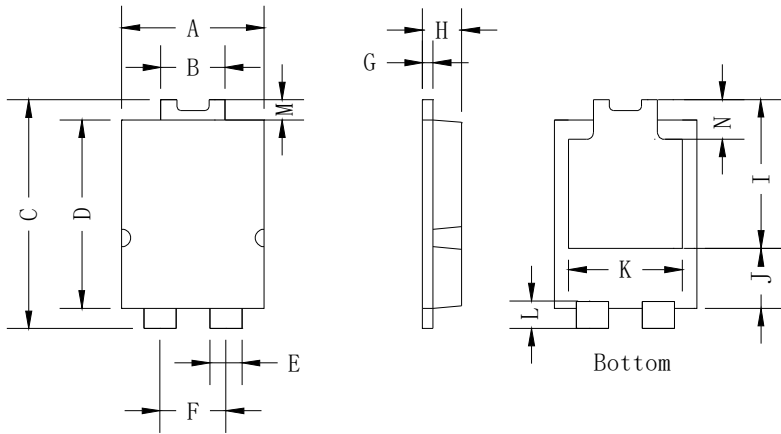

DIM	mm	
	MIN.	MAX.
A	3.90	4.10
B	1.70	1.90
C	6.40	6.60
D	5.30	5.50
E	0.80	1.00
F	1.85 ref.	
G	0.35	0.45
H	1.10	1.20
I	4.10	4.50
J	1.50	1.90
K	2.90	3.40
L	0.55	0.75
M	0.50 ref.	
N	1.15 ref.	

■ Suggested pad layout

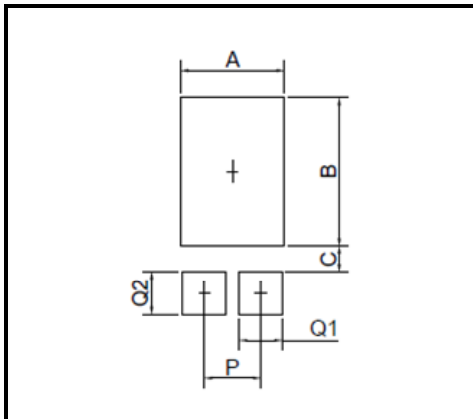

DIM	MIN.(mm)
A	3.36
B	4.86
C	0.85
P	1.84
Q1	1.40
Q2	1.40



SS15U100PQ

Disclaimer

The information presented in this document is for reference only. Yangzhou Yangjie Electronic Technology Co., Ltd. reserves the right to make changes without notice for the specification of the products displayed herein to improve reliability, function or design or otherwise.

The product listed herein is designed to be used with automotive electronics, are not designed for use in medical, lifesaving, lifesustaining, or military, Yangjie or anyone on its behalf, assumes no responsibility or liability for any damages resulting from such improper use of sale.

This publication supersedes & replaces all information previously supplied. For additional information, please visit our website [http:// www.21yangjie.com](http://www.21yangjie.com) , or consult your nearest Yangjie's sales office for further assistance.