

N-Channel Enhancement Mode Field Effect Transistor

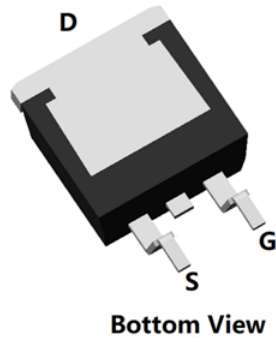

TO-263

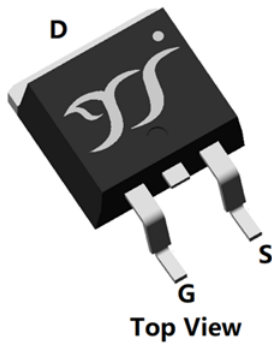
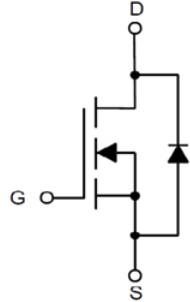

Product Summary

- V_{DS} 40V
- I_D 133A
- $R_{DS(ON)}$ (at $V_{GS}=10V$) $< 3m\Omega$
- $R_{DS(ON)}$ (at $V_{GS}=4.5V$) $< 5m\Omega$
- 100% EAS Tested
- 100% ∇V_{DS} Tested

General Description

- Split gate trench MOSFET technology
- Excellent package for heat dissipation
- High density cell design for low $R_{DS(ON)}$
- Moisture Sensitivity Level 1
- Epoxy Meets UL 94 V-0 Flammability Rating
- Halogen Free
- Part no. with suffix "Q" means AEC-Q101 qualified

Applications

- Power switching application
- Uninterruptible power supply
- DC-DC converter

Limiting Values

Parameter	Conditions		Symbol	Min	Max	Unit
Drain-source Voltage			V_{DS}	-	40	V
Gate-source Voltage			V_{GS}	-20	20	
Continuous Drain Current (Note 1,2)	Steady-State	$T_A=25^\circ C, V_{GS}=10V$	I_D	-	24.9	A
		$T_A=100^\circ C, V_{GS}=10V$		-	17.6	
Continuous Drain Current (Note 1,3)	Steady-State	$T_C=25^\circ C, V_{GS}=10V, \text{Chip limitation}$		-	133	
		$T_C=100^\circ C, V_{GS}=10V$		-	94	
Pulsed Drain Current	$T_C=25^\circ C, t_p \leq 10\mu s$		I_{DM}	-	532	
Maximum Body-Diode Continuous Current	$T_C=25^\circ C$		I_S		85	
Avalanche energy (non-repetitive)	$T_J=25^\circ C, V_G=10V, R_G=25\Omega, L=0.5mH, I_{AS}=26A$		EAS	-	169	mJ
Total Power Dissipation (Note 1,2)	Steady-State	$T_A=25^\circ C$	P_D	-	3.3	W
		$T_A=100^\circ C$		-	1.6	
Total Power Dissipation (Note 1,3)	Steady-State	$T_C=25^\circ C$		-	96	
		$T_C=100^\circ C$		-	48	
Junction and Storage Temperature Range			T_J, T_{STG}	-55	175	$^\circ C$

Thermal Resistance

Parameter		Symbol	Typ	Max	Units
Thermal Resistance Junction-to-Ambient (Note 2)	Steady-State	$R_{\theta JA}$	-	45	$^\circ C/W$
Thermal Resistance Junction-to-Case	Steady-State	$R_{\theta JC}$	-	1.56	

Ordering Information (Example)

PREFERRED P/N	PACKING CODE	Marking	MINIMUM PACKAGE(pcs)	INNER BOX QUANTITY(pcs)	OUTER CARTON QUANTITY(pcs)	DELIVERY MODE
YJB3D0G04AQ	F2	YJB3D0G04A	800	/	8000	13" reel



YJB3D0G04AQ

■ Electrical Characteristics

Parameter	Symbol	Conditions	Min	Typ	Max	Units
Static Parameter						
Drain-Source Breakdown Voltage	BV _{DSS}	V _{GS} =0V, I _D =1mA, T _j =25°C	40	-	-	V
		V _{GS} =0V, I _D =10mA, T _j =25°C	40	-	-	V
Zero Gate Voltage Drain Current	I _{DSS}	V _{DS} =32V, V _{GS} =0V, T _j =25°C	-	-	1	μA
		V _{DS} =32V, V _{GS} =0V, T _j =100°C	-	-	100	
Gate-Source Leakage Current	I _{GSS}	V _{GS} =±20V, V _{DS} =0V, T _j =25°C	-	-	±100	nA
Gate Threshold Voltage	V _{GS(th)}	V _{DS} =V _{GS} , I _D =250μA, T _j =25°C	1.2	1.7	2.4	V
Static Drain-Source On-Resistance	R _{DS(on)}	V _{GS} =10V, I _D =50A, T _j =25°C	-	2.3	3	mΩ
		V _{GS} =4.5V, I _D =25A, T _j =25°C	-	3.6	5	mΩ
Diode Forward Voltage	V _{SD}	I _S =50A, V _{GS} =0V, T _j =25°C	-	0.86	1.2	V
Gate Resistance	R _G	f=1MHz, T _j =25°C	-	1.9	-	Ω
Dynamic Parameters						
Input Capacitance	C _{iss}	V _{DS} =20V, V _{GS} =0V, f=1MHz, T _j =25°C	-	2370	-	pF
Output Capacitance	C _{oss}		-	1070	-	
Reverse Transfer Capacitance	C _{rss}		-	94	-	
Switching Parameters						
Total Gate Charge	Q _g	V _{GS} =10V, V _{DS} =20V, I _D =50A, T _j =25°C	-	45.7	-	nC
Gate-Source Charge	Q _{gs}		-	9.7	-	
Gate-Drain Charge	Q _{gd}		-	10.4	-	
Reverse Recovery Charge	Q _{rr}	I _F =50A, di/dt=100A/μs, V _{GS} =0V, V _R =20V, T _j =25°C	-	12	-	nC
Reverse Recovery Time	t _{rr}		-	24.6	-	ns
Turn-on Delay Time	t _{D(on)}	V _{GS} =10V, V _{DS} =20V, I _D =50A, R _L =0.4Ω, R _{GEN} =3Ω, T _j =25°C	-	12.3	-	ns
Turn-on Rise Time	t _r		-	110	-	
Turn-off Delay Time	t _{D(off)}		-	36.8	-	
Turn-off Fall Time	t _f		-	22	-	

Note:

- The entire application environment impacts the thermal resistance values shown, they are not constants and are only valid for the particular conditions noted.
- The value of R_{θJA} is measured with the device mounted on the 40mm*40mm*1.1mm single layer FR-4 PCB board with 1 in² pad of 2oz. Copper, in the still air environment with T_A=25°C. The maximum allowed junction temperature of 175°C. The value in any given application depends on the user's specific board design.
- Thermal resistance from junction to soldering point (on the exposed drain pad).



YJB3D0G04AQ

Typical Electrical and Thermal Characteristics Diagrams

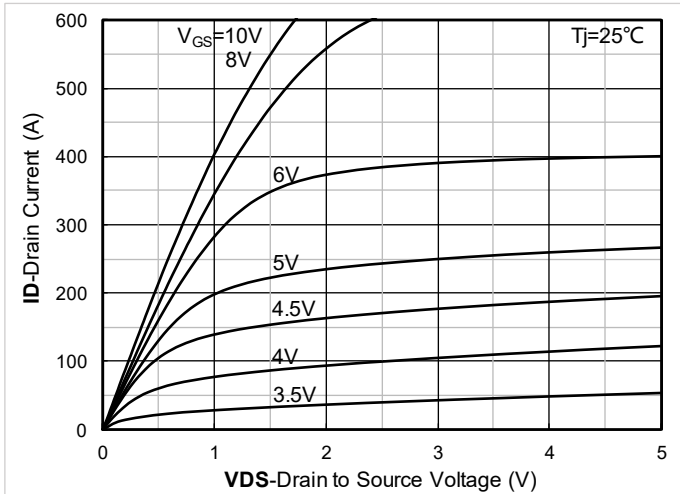

Figure 1. Output Characteristics; typical values

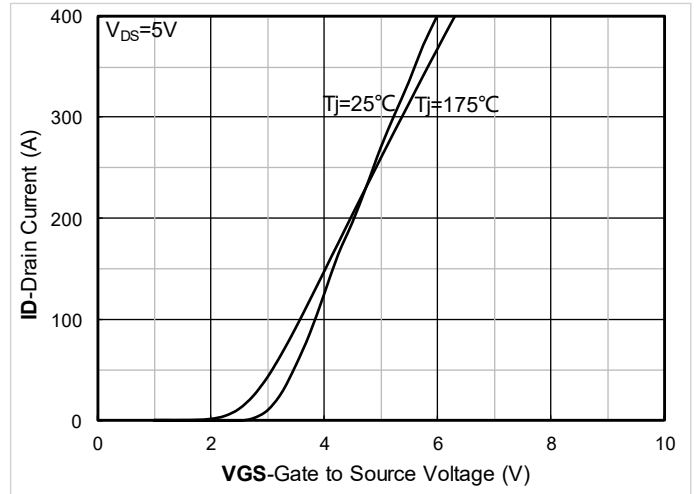

Figure 2. Transfer Characteristics; typical values

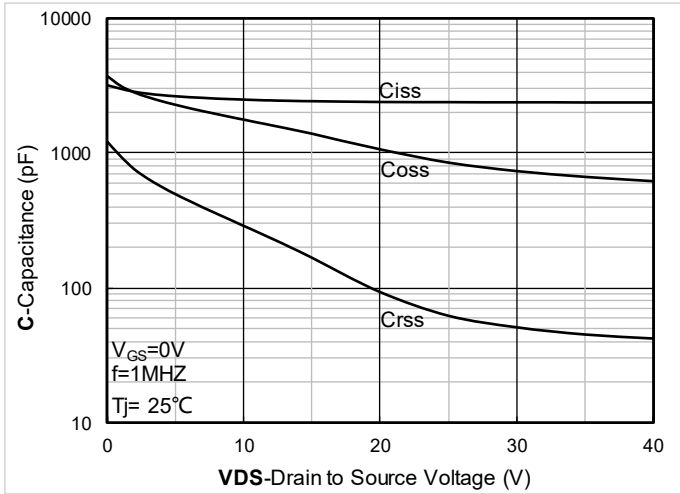

Figure 3. Capacitance Characteristics; typical values

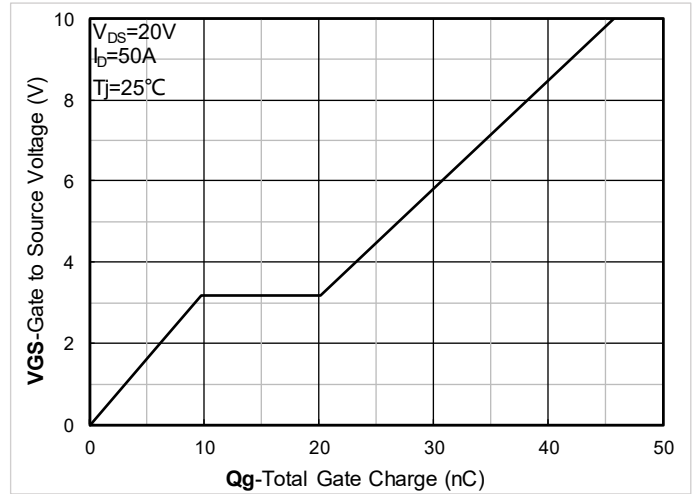

Figure 4. Gate Charge; typical values

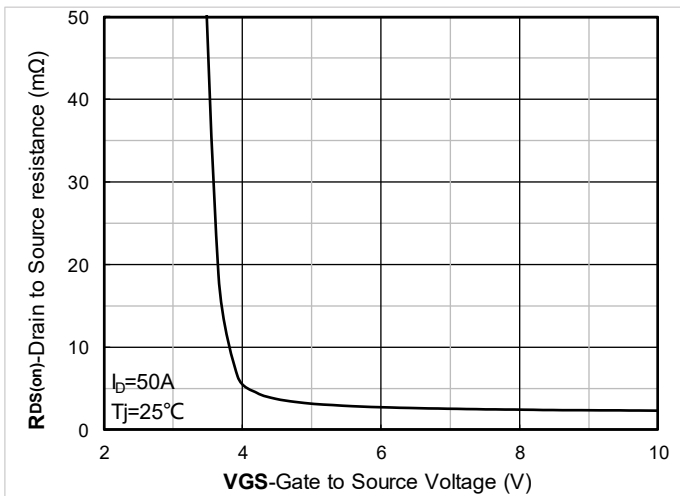

Figure 5. On-Resistance vs. Gate to Source Voltage; typical values

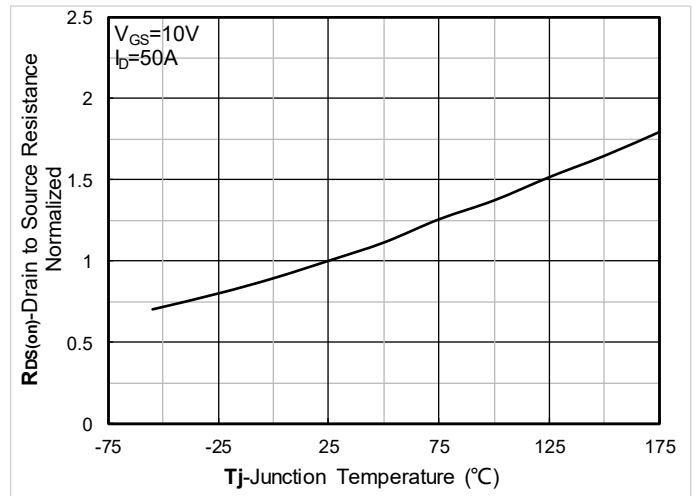

Figure 6. Normalized On-Resistance



YJB3D0G04AQ

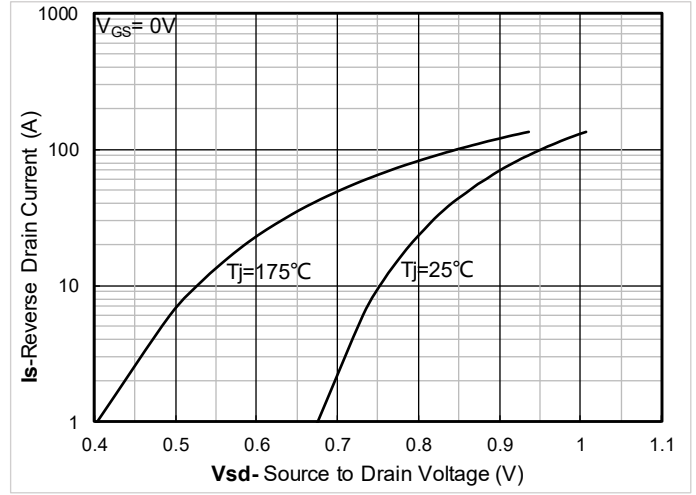
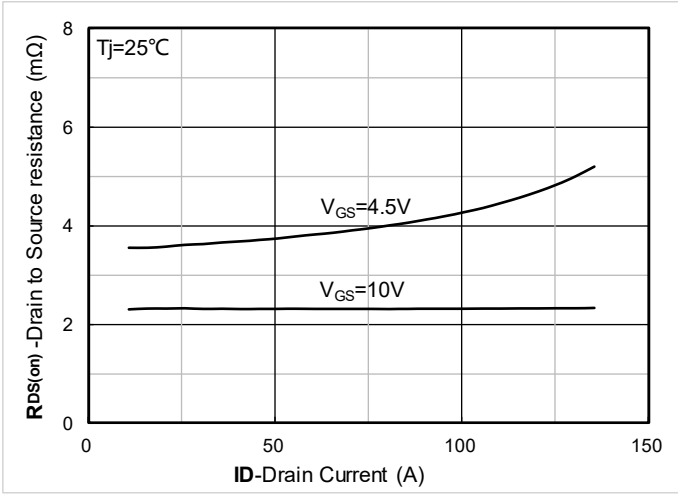

Figure 7. RDS(on) vs. Drain Current; typical values

Figure 8. Forward characteristics of reverse diode; typical values

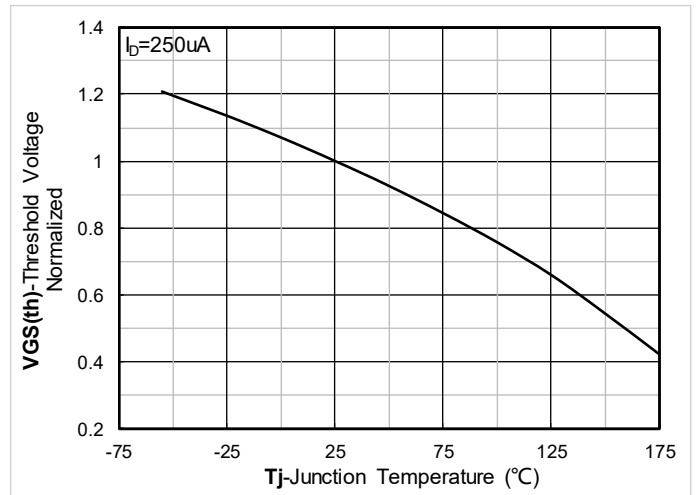
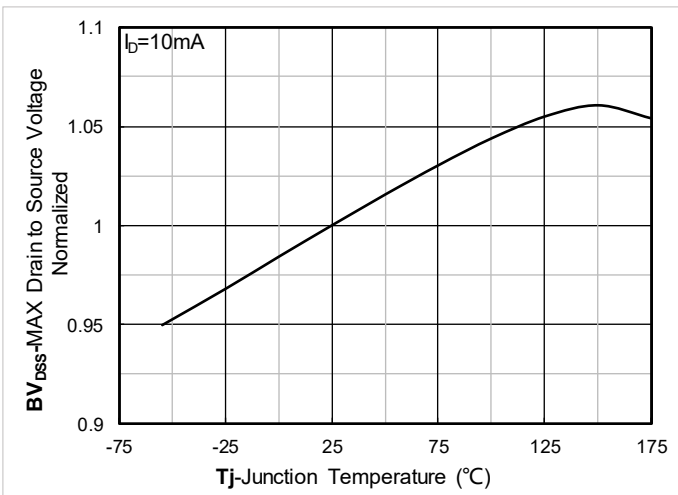

Figure 9. Normalized breakdown voltage

Figure 10. Normalized Threshold voltage

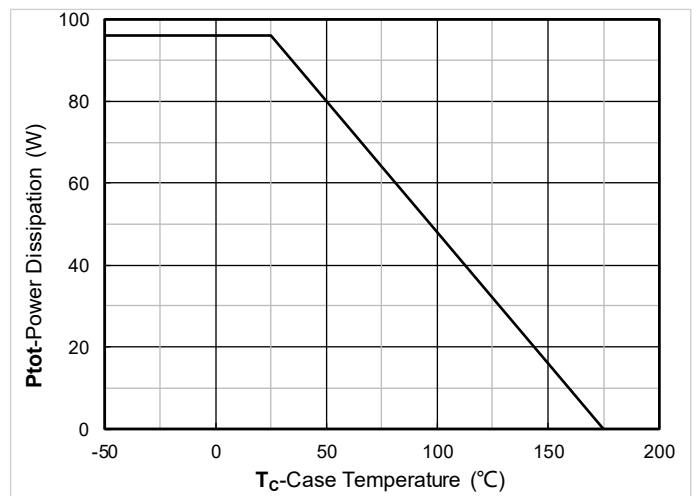
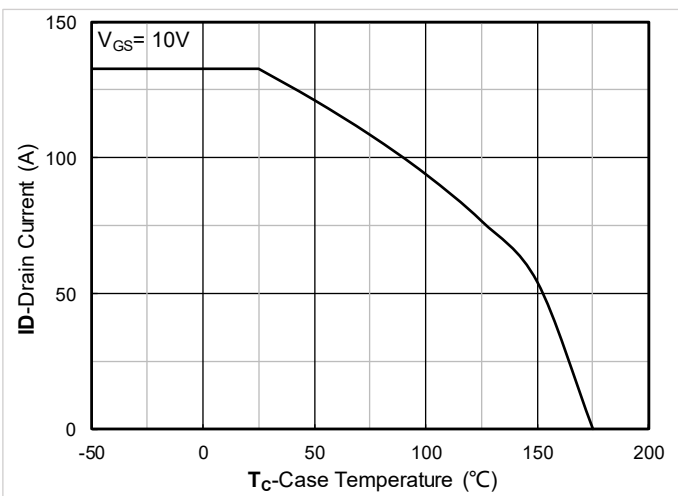

Figure 11. Current dissipation

Figure 12. Power dissipation



YJB3D0G04AQ

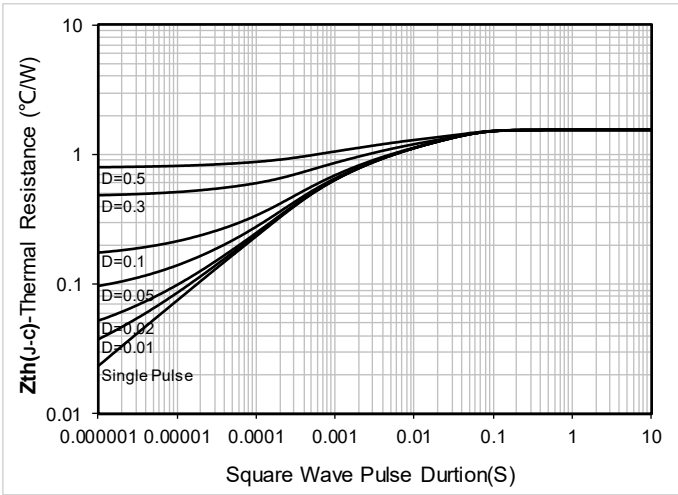

Figure 13. Maximum Transient Thermal Impedance

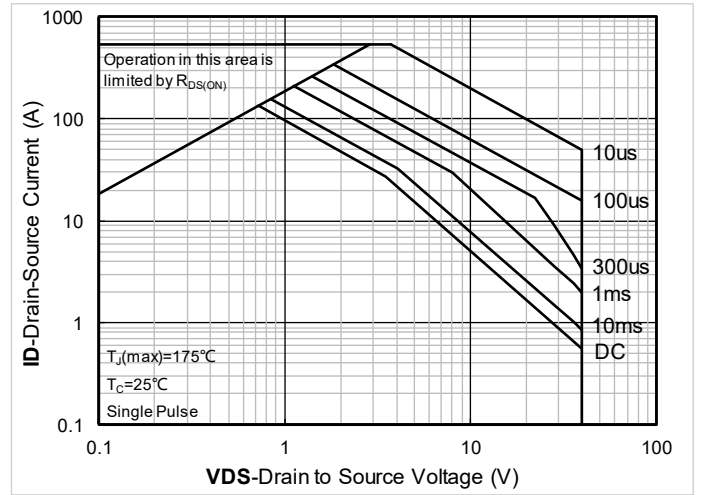

Figure 14. Safe Operation Area

■ Test Circuits & Waveforms

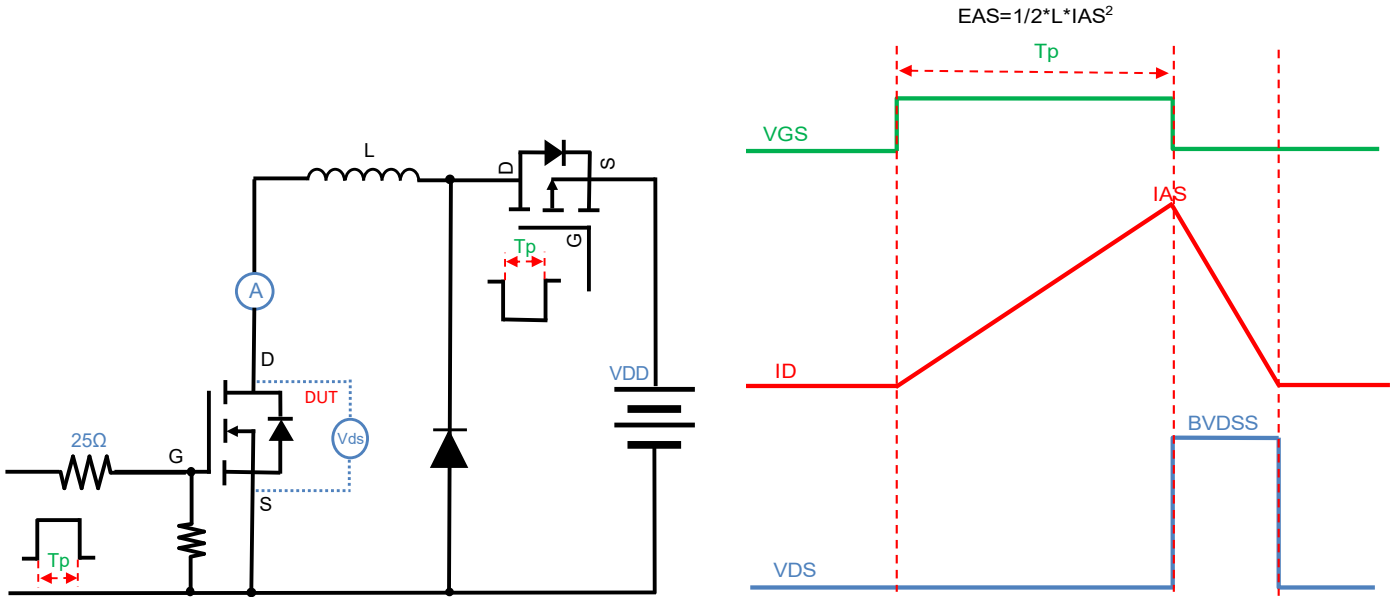

Figure A. Unclamped Inductive Switching (UIS) Test Circuit & Waveform

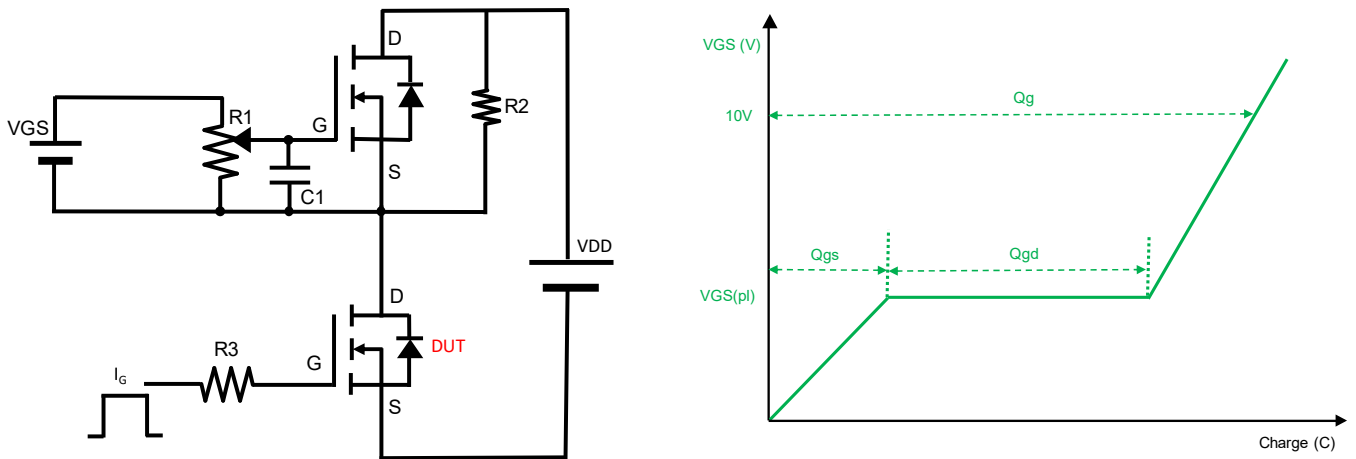

Figure B. Gate Charge Test Circuit & Waveform

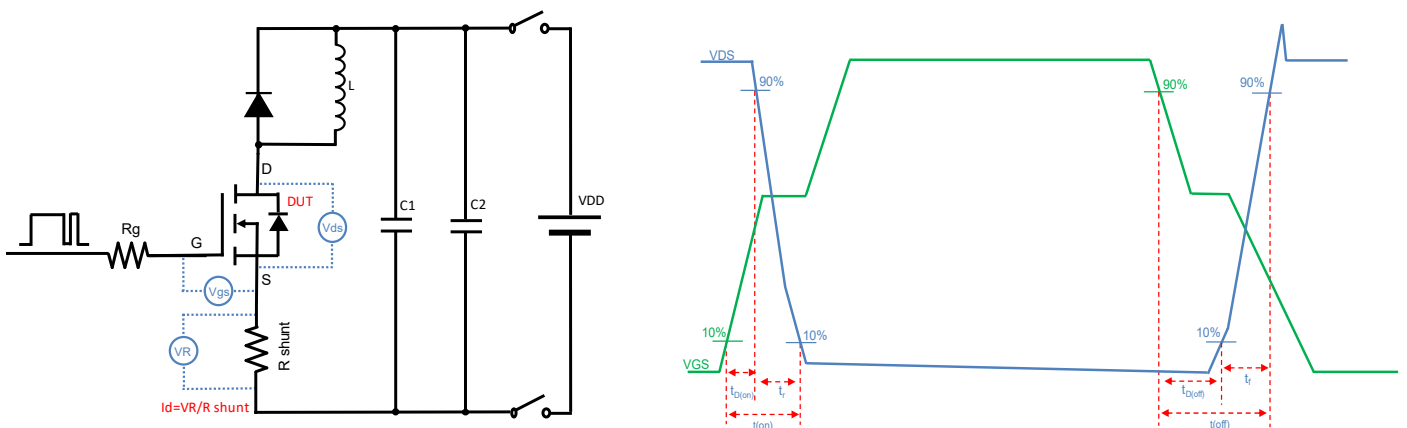

Figure C. Resistive Switching Test Circuit & Waveform

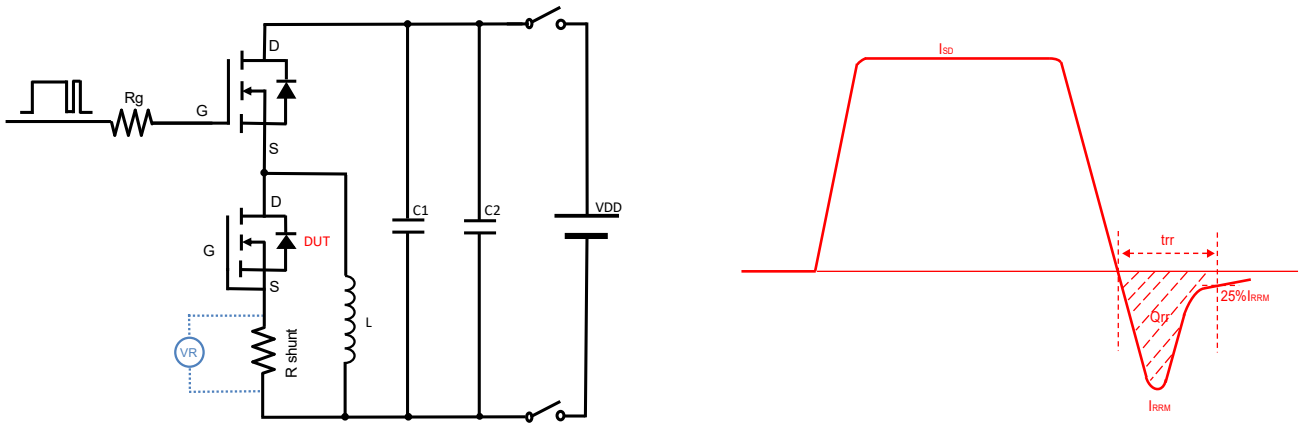
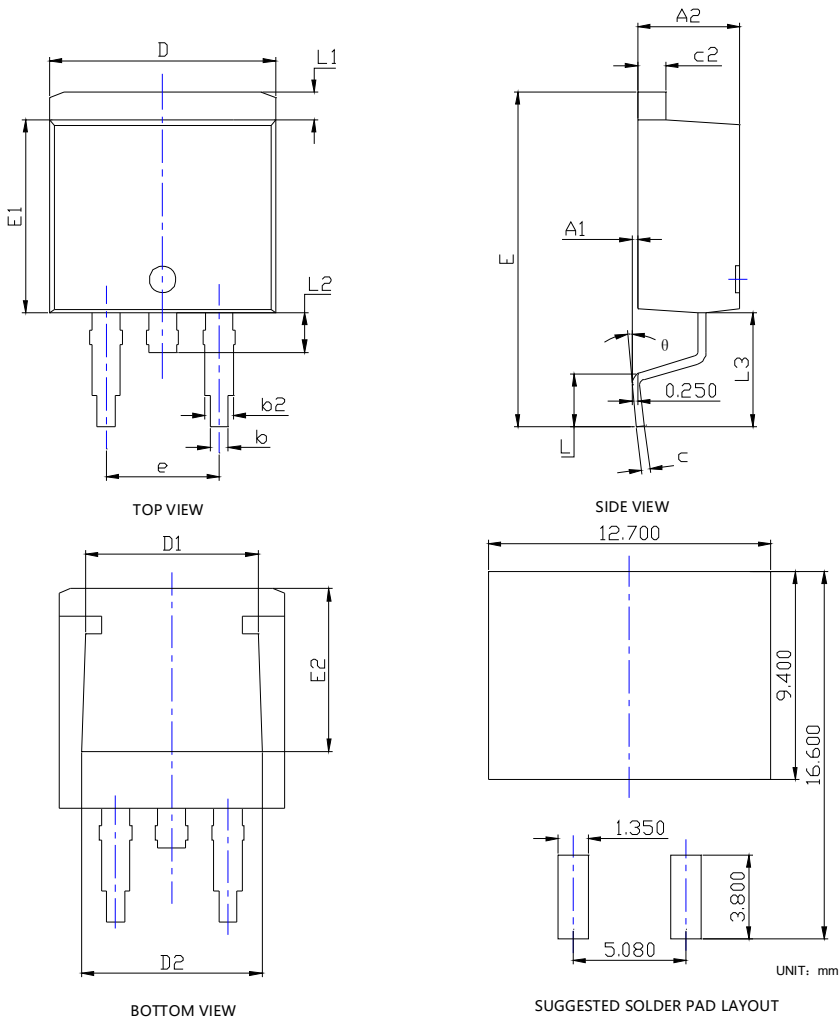

Figure D. Diode Recovery Test Circuit & Waveform



YJB3D0G04AQ

■ TO-263-HY Package information



SYMBOL	DIMENSIONS					
	INCHES			Millimeter		
	MIN.	NOM.	MAX.	MIN.	NOM.	MAX.
A1	0.000	---	0.010	0.000	---	0.250
A2	0.174	0.180	0.186	4.430	4.580	4.730
b	0.028	0.032	0.036	0.720	0.820	0.920
b2	0.046	0.050	0.054	1.180	1.280	1.380
c	0.013	0.015	0.018	0.330	0.390	0.450
c2	0.048	0.050	0.053	1.220	1.280	1.340
D	0.394	0.400	0.406	10.000	10.150	10.300
D1	0.295	0.307	0.319	7.500	7.800	8.100
D2	0.303	0.315	0.327	7.700	8.000	8.300
E	0.571	0.591	0.610	14.500	15.000	15.500
E1	0.337	0.341	0.348	8.550	8.700	8.850
E2	0.276	0.287	0.299	7.000	7.300	7.600
e	0.200BSC			5.080BSC		
L	0.070	---	0.110	1.790	---	2.790
L1	0.044	---	0.056	1.120	---	1.420
L2	0.030	---	0.070	0.770	---	1.770
L3	0.197REF			5.000REF		
θ	0°	---	8°	0°	---	8°

NOTE:

- 1.PACKAGE BODY SIZES EXCLUDE MOLD FLASH AND GATE BURRS.
- 2.TOLERANCE 0.1mm UNLESS OTHERWISE SPECIFIED.
- 3.THE PAD LAYOUT IS FOR REFERENCE PURPOSES ONLY.



YJB3D0G04AQ

Disclaimer

The information presented in this document is for reference only. Yangzhou Yangjie Electronic Technology Co., Ltd. reserves the right to make changes without notice for the specification of the products displayed herein to improve reliability, function or design or otherwise.

The product listed herein is designed to be used with automotive electronics, are not designed for use in medical, life-saving, lifesustaining, or military, Yangjie or anyone on its behalf, assumes no responsibility or liability for any damages resulting from such improper use of sale.

This publication supersedes & replaces all information previously supplied. For additional information, please visit our website <http://www.21yangjie.com>, or consult your nearest Yangjie's sales office for further assistance.